

Body Package Quote to Order Form

RSM Name	
Dealer Name	
Customer	
Date Submitted	
Date Quote Required	
Date Requested for Delivery	
Quote Number (Assigned by Auto Crane)	

Customization Required **Upfitted By (Required):** Auto Crane Dealer
 (When body and/or accessories are not part of price book)

***If Upfitted by Auto Crane, Page 5 must be filled out by Sales, Dealer, Customer Service, or End User**

Titan 60-84CA-52" Tall

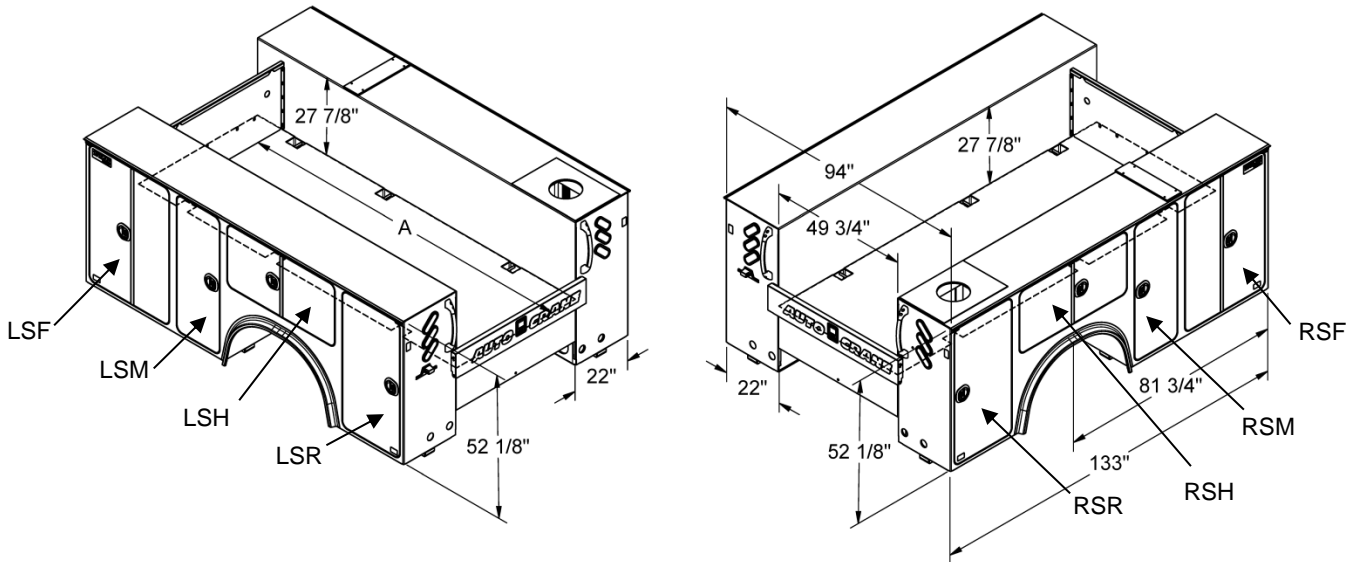

General Description

Package Overview	Description
Body Configuration (if different than shown above)	
Bulkhead – Standard, Recessed or Custom (Required)	
Chassis Make and Model	
Hydraulic Power Source	

*For any additional items please use blanks above

General Body Accessories and Requirements

For **quotes** e-mail to: acquotes@autocrane.com
 For **orders** e-mail to: accustomersupport@autocrane.com

General Body Accessories and Requirements

Accessory	Description	Location	Installed at A/C?
Outriggers			
Bumper			
Bumper Accessories			
Master Locking System (Yes or No)			
Light Bar or Headache Rack			
Interior Lighting (LED or Dome Lights)			
Exterior Lighting			
Receiver Hitch			
Compressor			
Brackets			
Air Filter, Regulator, Lubricator			
Hose Reel w/ 50' of 1/2" Hose			
Hose Reel w/ 50' of 1/2" Hose w/ CS Rear Exit and 4-Way Roller			
Hose Reel w/ 50' of 3/4" Hose			
4-Way Roller to be used w/ Hose Reel			
Air Receiver Tank			
Hydraulic Reservoir			
Electrical Accessories			
Trailer Plug			
Control Panel			
Rear View Camera			
Body Installation Kit			

*For any additional items please use blanks above

Crane and Accessories

Accessory	Description	Location	Installed at A/C?
Crane			
Boom Tip Lights			
NexStar Cradle			
Boom Support			

Paint Options

Description	Indicate Items Needed	Paint Code / Description (if applicable)
Outside Paint (Choose only one)		
Custom Paint (Paint code required)	<input type="checkbox"/>	
Paint White (White Paint Code Required)	<input type="checkbox"/>	
Primer Only	<input type="checkbox"/>	
Inside Compartments (Choose only one)		
Custom Paint (Paint code required)	<input type="checkbox"/>	
Paint White (White Paint Code Required)	<input type="checkbox"/>	
Zolatone	<input type="checkbox"/>	
Primer Only	<input type="checkbox"/>	

Bed Liner Options

Description	Indicate Items Needed	Custom Locations
Bed Liner – Floor and Sides Only	<input type="checkbox"/>	
Bed Liner – Floor, Sides and Compartment Tops	<input type="checkbox"/>	
Bed Liner – Workbench Bumper	<input type="checkbox"/>	
Bed Liner – Front of Body	<input type="checkbox"/>	
Bed Liner – Custom	<input type="checkbox"/>	
Arctic Package	<input type="checkbox"/>	

Driver's Side Compartments

LSF (Vertical Front)	LSM (Vertical Mid)	LSH (Horizontal)	LSR (Vertical Rear)

Passenger Side Compartments

RSF (Vertical Front)	RSM (Vertical Mid)	RSH (Horizontal)	RSR (Vertical Rear)

Standard Shelving Package (Consists of: 1 shelf in each front vertical compartment, 3 shelves in each mid compartment, one shelf with dividers in each horizontal compartment, 3 shelves in the rear compartment opposite the crane box, and 3 material hooks in the crane compartment)

Accessories in Cargo Bay Area

Accessory	Indicate Items Needed	Description / Location
Cover or Sliding Top	<input type="checkbox"/>	
Mounting Brackets	<input type="checkbox"/>	
E-track	<input type="checkbox"/>	
	<input type="checkbox"/>	
	<input type="checkbox"/>	

*For any additional items please use blanks above

Notes

Chassis Information (Auto Crane Upfit):

Chassis Make _____ Chassis Model _____ Chassis Year _____

Transmission Make _____ Transmission Model _____

VIN _____

Chassis CA _____ Drive train _____

Battery Location (if applicable) _____

Customer Supplied Chassis must come with a clean, correct CA, and PTO port (if powered off transmission). Any modifications including but not limited to chassis changes may incur additional charges. This includes Battery Relocations, Frame/Exhaust Modifications, and Rear Axle Relocations

Chassis Special Requirements

Accessory	Description

Electrical Wiring Information (Auto Crane Upfit):

Switch Number	Crane Box Control Panel*		Upfitter Switches**	
	Label	Function	Label	Function
Switch #1				
Switch #2				
Switch #3				
Switch #4				
Switch #5				
Switch #6				

*739429526 (Crane Box Rocker Switch Panel) must be included with order

**Dodge only has 4 switches available, Ford Switches - #1-#4 are ignition feed and #5-#6 are battery feed. Crane power must be on battery feed.

Note: If 717515000 (Switch Panel) is ordered, it will be wired as followed unless otherwise noted in Other Notations field below:

Main Power – Turns on Crane and/or Enpak (if equipped), Beacon - Turns on Strobes or Beacons (if equipped),
 Compt Lights – Turns on interior compartment lights on both sides (if equipped), Top Flood Light Switch – Turns on front flood lights (4 lights or less) : Turns on left flood lights (more than 4 lights), Bottom Flood Light Switch – Turns on back flood lights (4 lights or less) : Turns on right flood lights (more than 4 lights)

Other Notations:

Notes

Customer Approval: _____ Date: _____

E-sign:

Production Information

(For Internal Use Only)

General Information:

Sales Order # _____

Date _____

Body Serial# _____

CSR _____

Customer _____

PO # _____

No. of Units _____

Notes